

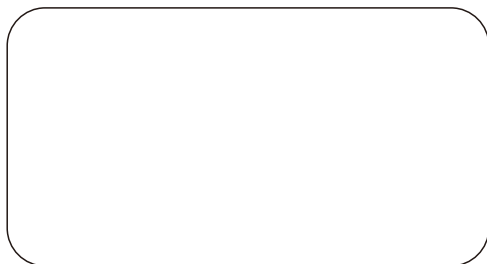

# FINGERPRINT LOCK

## INSTALLATION INSTRUCTIONS



# Packing List

Open the product package. Check that the following accessories are included.

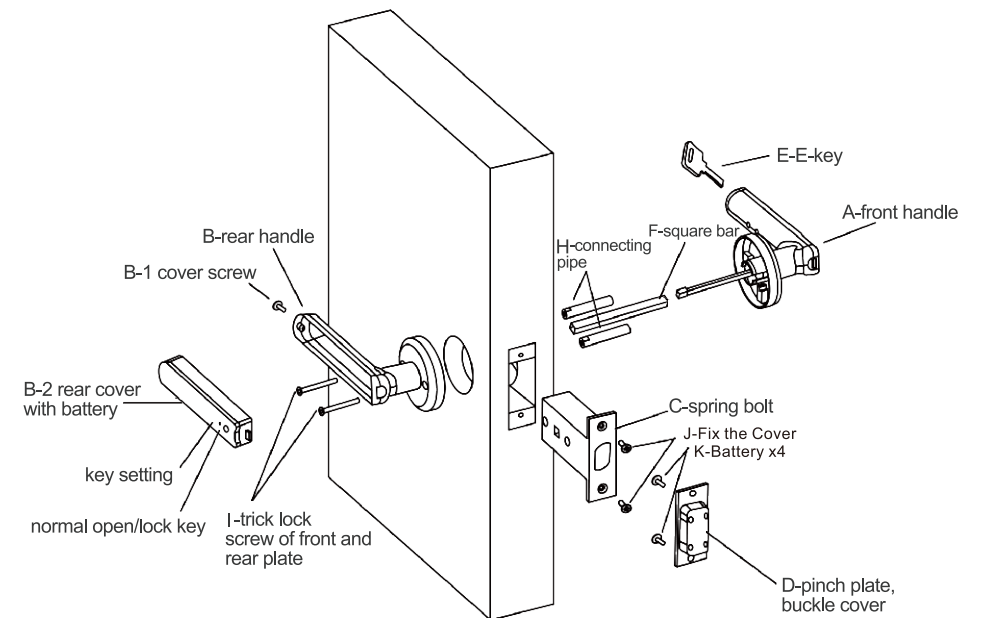
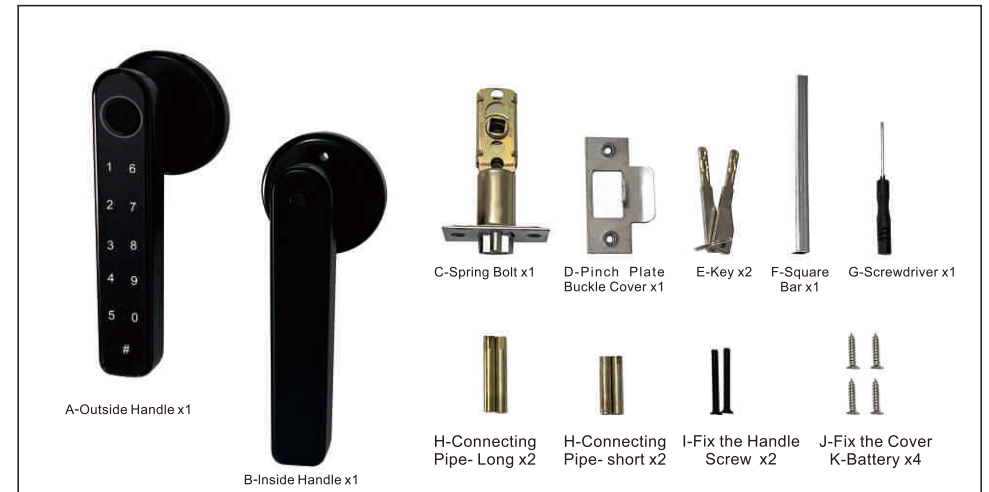
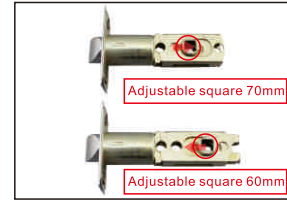

**Diagram of Door Lock Installation**

# Installation Steps



Pass the square along the wire



2. The hole position can be adjusted according to the door lock position

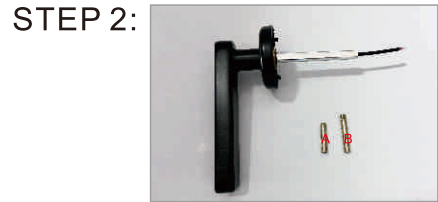

Choose the screw of the corresponding length according to the thickness of the door and tighten the screws



Install and fix the door handle



Open the battery cover to install the battery



Connect door lock circuit board port

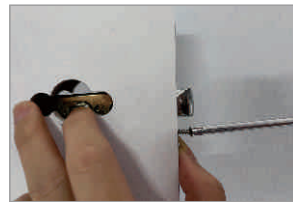

Install the deadbolt

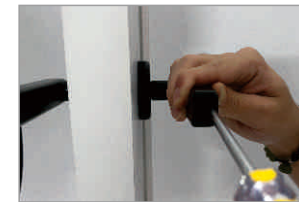

Tighten the screws securing the battery cover

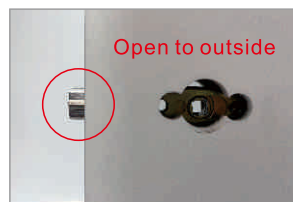

1. Pay attention to the direction of the lock tongue when you installing

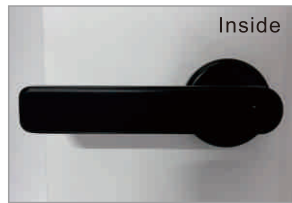
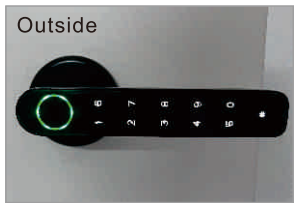

After completing the above steps, the door lock installation is complete

### Set password:

CAUTION;Any fingerprint can unlock it if no user is enrolled.

## Indoor Intelligent Lock Bluetooth Tuya Operation Guide

### Introduction and acquisition of APP

"Tuya Smart APP" is an intelligent device management APP provided by Tuya to end consumers. Through the "Tuya Smart APP", you can conveniently configure and control the smart products in the whole house, configure your favorite scenes and automation schemes, share your smart devices with family and friends, and enjoy the fun of smart in the whole house.

Acquisition APP: Search for "Tuya Smart" in the application market or "Apple Mall" or scan the following QR code to download.

This document takes Smart Life APP as an example to explain the functions of APP& door lock

panel in detail.



## I. APP registration, login

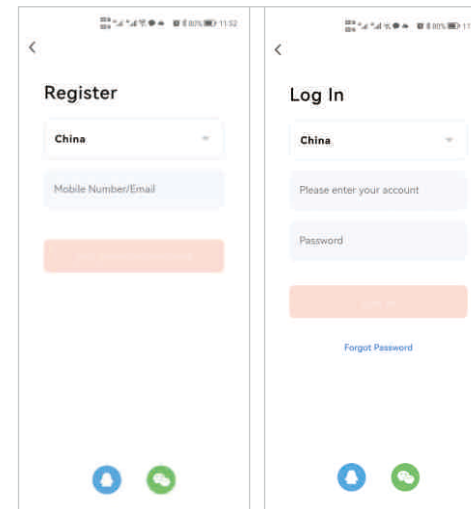

APP registration: choose to register if without an APP account or log in through SMS verification code.

Click "Create a new account" to enter the account registration page. Get SMS verification code and set password according to the prompt.

If you already have an existing account, you can click "Log in with an existing account" to log in to the APP. Login mode supports password, verification code and social account login.

## II.Add bluetooth door lock

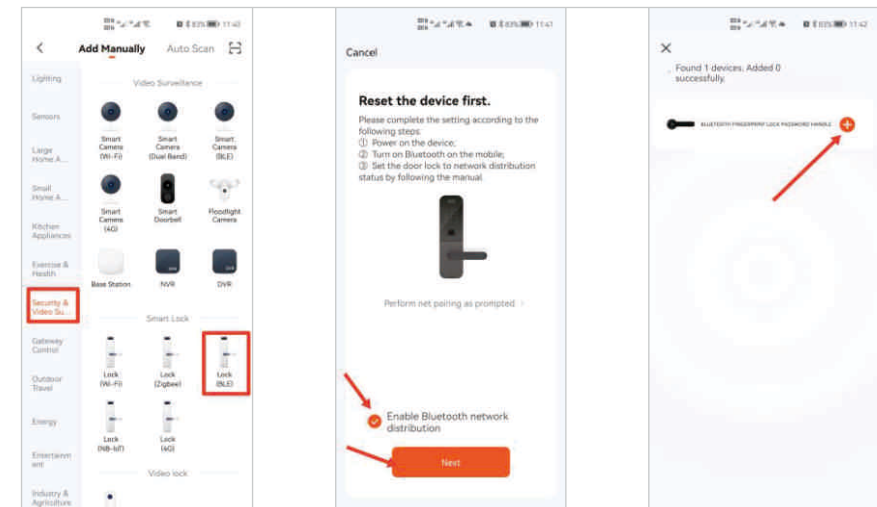

1. Click the "add device" icon on the homepage of APP.
2. Click the "Security monitoring" category on the left and find and click "Smart Door Lock".
3. Start Bluetooth network distribution and click "Next".
4. Wake up the door lock keyboard, or touch the fingerprint to wake up, wait for the mobile phone to scan the device, and press the "+" icon to add the device.
5. Waiting for the device to be added, the door lock emits "Drip" twice, indicating that the device is successfully added.

## III. Bluetooth door lock panel—homepage

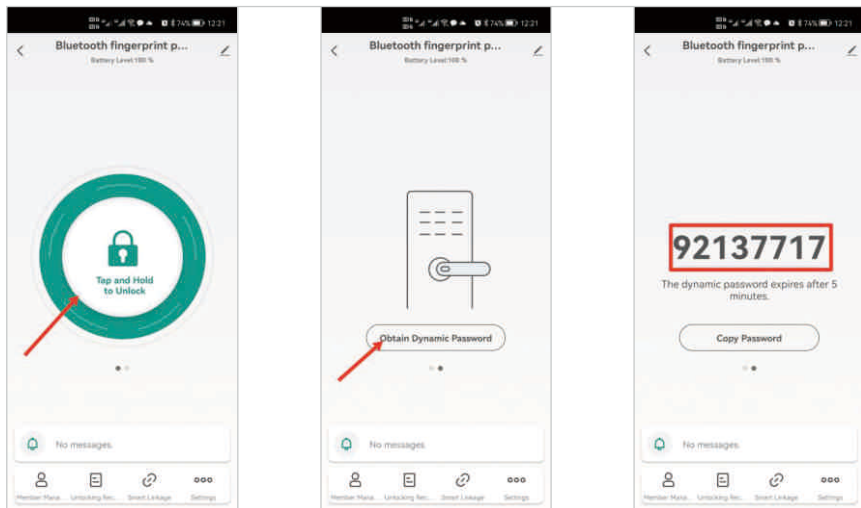

1. The lower side of the homepage contains the names of the displayed door lock and the current power condition on the upper side of the homepage of "Member Management", "Unlocking Record", "Smart Linkage" and "Settings". The connection status of Bluetooth will be displayed in the homepage center. If it is connected, you can click "Long press to unlock" and directly unlock the door lock (Please make sure the Bluetooth of the mobile phone is turned on and the mobile phone is within a reasonable distance from the door lock. It is recommended to operate within 5 meters); If Bluetooth is not connected, "Bluetooth cannot be connected" is displayed, and the Bluetooth door lock cannot be opened directly through APP.
3. The homepage slides to the left to the next page, with dynamic password function. After clicking "Get Dynamic Password", a group of 8-digit passwords will appear randomly. You can use this digital password to unlock the door within 5 minutes.

#### IV. Member management-family member management

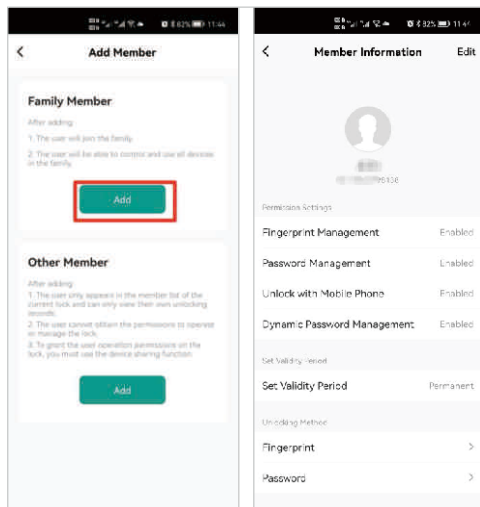

1. Validity period: once added, the permission of using time of family members is permanent until the administrator deletes the member, and the members always have the corresponding permission.
2. Door opening method: The administrator can decide the permission type of the member; As shown in the figure, if the administrator closes all the door opening permissions of the member, the user can no longer maintain his own door opening mode through APP, and can only use the existing door opening mode.
3. Create/delete the door opening mode. By connecting the door lock with APP Bluetooth, the administrator can create/delete the door opening for other family members.

#### V. Member management-other member management

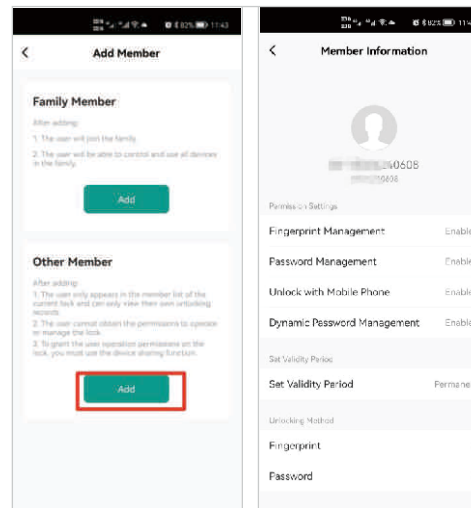

1. Validity period: the administrator can decide the length of validity period of other members. It can be set as permanent, or set the specified start time-end time.
2. Door opening mode: the administrator can decide the permission type of the door opening mode possessed by the member; As shown in the figure, if the administrator closes all the door opening permissions of the member, the user can no longer maintain his own door opening mode through APP, and can only use the existing door opening mode.
3. After creating another member, the administrator can associate the member with a certain user of APP by "sharing". When the specified end time of the user arrives, the user's APP will automatically lose the device.

#### VI. Fingerprint management

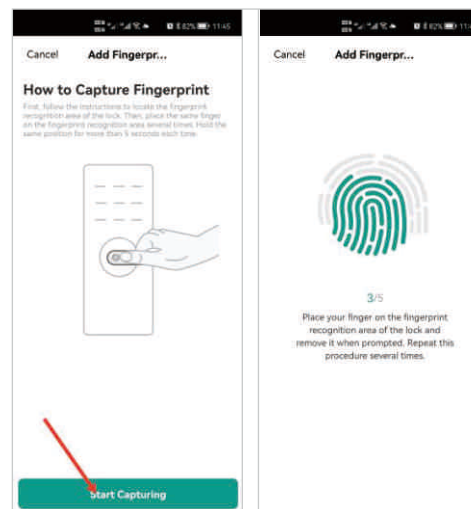

1. Before selecting "fingerprint management" for collection, select the user corresponding to the fingerprint to be added.
2. Click "Start Collection" to enter the fingerprint collection interface. For each fingerprint collection, multiple fingerprints need to be entered (the manufacturer can customize the collection times).
3. Connect the door lock through APP Bluetooth, and the administrator can collect fingerprints for himself or other family members.

#### VII. Password management

1. Select "password management" as the entry of the home page.
2. Before adding a password, select the user corresponding to the password to be added.
3. Click "Add Password" to enter the password entry interface, which supports random generation and user-defined passwords.
4. Connect the door lock through APP Bluetooth, and the administrator can enter the password for himself or other family members.

#### VIII. Temporary password management

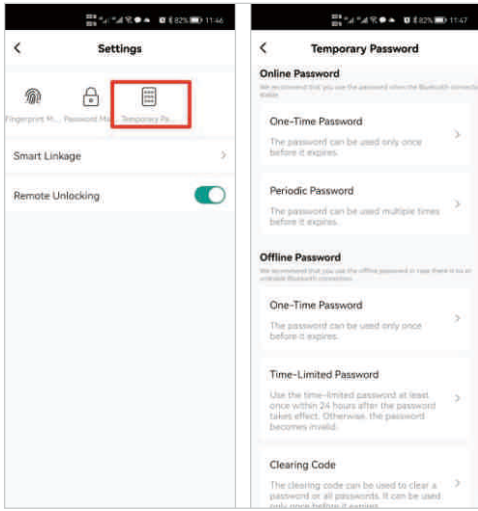

- 1.Home page setup entry-select "temporary password management"
- 2.You can choose "one-time password" or "periodic password" according to user's requirements.
- 3.Please select "Online Password" when the Bluetooth signal is good, and select "Offline Password" when the Bluetooth signal is disconnected or poor.

### IX. Door opening record.

The log can be queried in the " Door Opening Record" entry of the homepage, and the records are arranged in reverse order. The unlocking ID that has been associated with the user name will directly display the corresponding user name, and the unlocking ID that has not been associated with the name from the APP will display the specific unlocking ID; About the record of door opening: when the door lock is connected with Bluetooth of mobile phone, the record of door opening will be displayed on APP in real time, otherwise, the record will be cached locally in the door lock, and it will be retransmitted after the door lock is connected with Bluetooth of mobile phone and opened next time.

### X. Restore the factory settings

Click the icon in the upper right corner of the main page, enter the interface, find "Remove device", and select "Unbind and clear data".

1. When the mobile phone APP is connected to the door lock by Bluetooth, the factory reset operation is used. All local door opening methods of the door lock will be deleted, and the door lock will be restored to its original factory default state. Other users can re-add the door lock through APP.
2. When the mobile phone is not connected with the door lock by Bluetooth, restore the factory settings of the door lock on the door lock. The way of opening the door on the door lock remains unaffected. Other users can re-pair with the door lock through APP. The original unlocking method of the rare door lock will be invalid.
3. Press the setting button in the small hole of the rear handle for 5 seconds, and the door lock will make a long "drip" sound, which will force the factory settings to be restored. All the door opening methods on the door lock will be deleted, and the door lock will be restored to its original factory default state. Other users can add the door lock again through APP.

### XI. Normally open setting/cancel normally open

#### After indoor handle

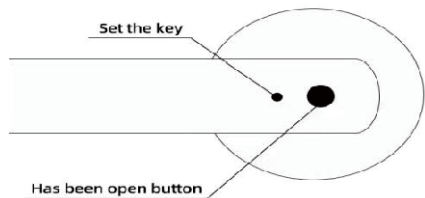

- 1.Normally open setting: press the normally open button for 1 second in the rare handle and the door lock will make a "drip" sound to open the normally open mode;
2. ① Cancel the normally open mode: Press the normally open button for 1 second in the rare handle, and the door lock will make a "drip" sound to close the normally open mode;  
② Automatically cancel the normally open mode after verifying that the administrator or user is correct;
- ③ Press the "#" key in the front handle to cancel the normally open mode.

## Other Settings

### 1.Two Ways to Reset and Delete All the Users

#### Method 1:

##### STEP 1:

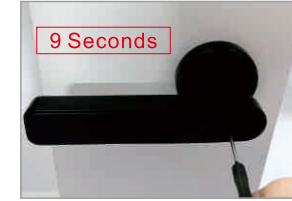
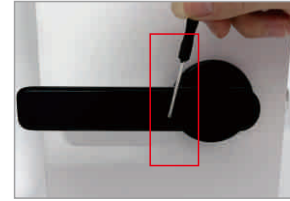

Long press the small hole on the inside handle with a small screwdriver for 9 seconds

##### STEP 2:

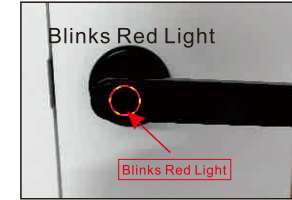

When the indicator blinks red light, stop the operation, the reset is successful

#### Method 2:

##### STEP 1:



Enter "888 "+"#", and the indicator will blink red light

##### STEP 2:



Press the registered adminis- trator fingerprint, the reset is successful

## 2. Two Ways to Turn ON Normally-Open Mode

### Method 1:

#### STEP 1:

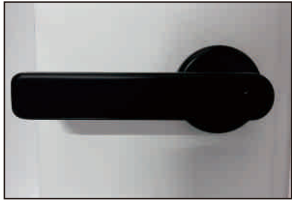

Long press the button on the inside handle for 1 second

#### STEP 2:

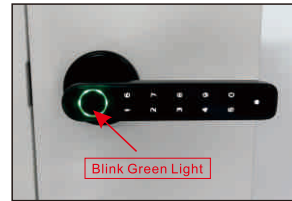

When the indicator light turns green, release the button

### Method 2:

#### STEP 1:



Touch to wake up the password area

#### STEP 2:

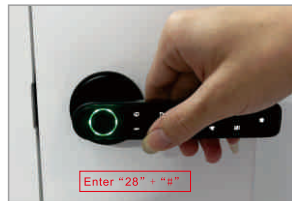

Enter "28"+"#", and the indicator will blink purple light

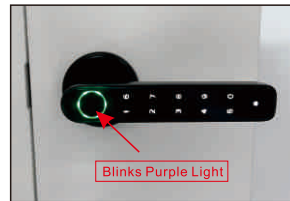

#### STEP 3:



Press the registered administrator fingerprint

## 3. Four Ways to Turn OFF Normally-Open Mode

- Repeat the above 2 methods to turn off the normally open mode
- Press "#" to lock and turn off the normally open mode
- Enter an enrolled fingerprint or password to lock up

## 4. Emergency Unlock

### Method 1:

#### STEP 1:



Plug the USB power cord into the connector

#### STEP 2:

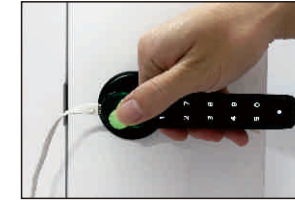

Press the registered administrator fingerprint

#### STEP 3:



Unlocking is successful

## Useful Tips

- Keep at least one key out of the door for emergency.
- When the battery is low, the indicator will blink red light. The rest power could only be used for about 50 times.
- When the battery is out of power, you can unlock the door with key, or supply the lock with power through the micro-USB port and use fingerprint or password to unlock it.
- Use alkaline batteries to prevent the damage by battery leakage. Batteries must be replaced every 2 years.

## Product Parameters

- Number of fingerprints: 50
- Number of passwords: 100
- Power supply: 4 AAA 1.5V alkaline batteries

## After-Sales Service

If you have any problem during installation or operation, please contact us.

## Useful Tips:

1. Keep at least one key out of the door for emergency.
2. When the battery is low, the indicator will blink red light. The rest power could only be used for about 50 times.
3. When the battery is out of power, you can unlock the door with key, or supply the lock with power through the micro-USB port and use fingerprint or password.
4. Use alkaline batteries to prevent the damage by battery leakage. Batteries must be replaced every 2 years.

## Q&A:

**Q: The button doesn't respond and light doesn't light up?**

**A: Check the cable if it connects to the right way or it's loose. After this it's still can't work, normally it's the battery dead. It needs to change the batteries (4\*1.5V AAA battery), or pull out the inner back cover and insert it again.**

**Q: Which model of the door can install the fingerprint door lock ?**

**A: There is no limit. If the door thickness more than 3.5cm-6.5cm then it can install.**

**Q: How to restore the factory settings ?**

**A: Long click the setting button 5s, the blue light will shine and have the bee sound. After 5s will have the red light shining and have a voice remainder "initial success", This means successful.**

**Q: What is the initial password if the fingerprint lock is restored to the factory setting?**

**A: Initial password is "123456"#**

**Q: How to do if the lock runs out of the battery?**

**A: Use the power bank to connect the USB port to charge then use the key to open the door.**

**Q: How to do if you forget the password?**

**A: Use the fingerprint or key to unlock the door and then restore the factory settings to reset the password.**