

Apartment Smart Lock User Manual

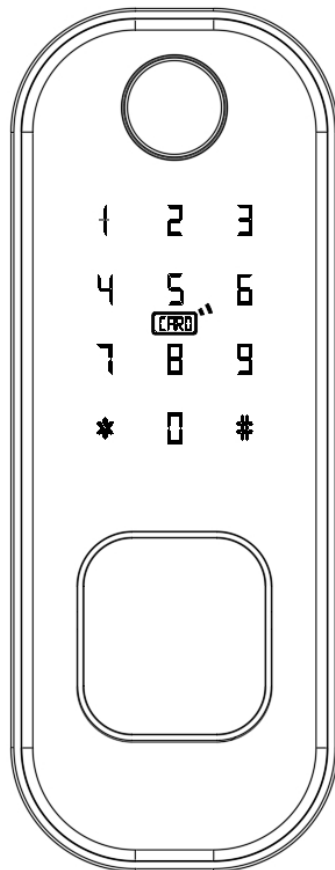

Please read the manual carefully before use

Note:

- * Please carry the mechanical key with you or put it in an outdoor safe place for any emergency use.
- * Do not install this lock in a fire exit door.

1) Before installation

1.1) Professional installation is recommended.

1.2) To avoid any circuit function fault, please do not crumple the cable.

1.3) Keep the door open until finishing the installation and lock function test.

1.4) Please check whether fingerprint, card, password, key, inside knob unlock function well after installation (under initial status, any fingerprint, IC card or 4 digit password is able to unlock).

1.5) If any function mentioned above doesn't work appropriately, check again if the cable is well connected or if there any improper operation during installation then reinstall it strictly following our diagram.

2) Installation diagram

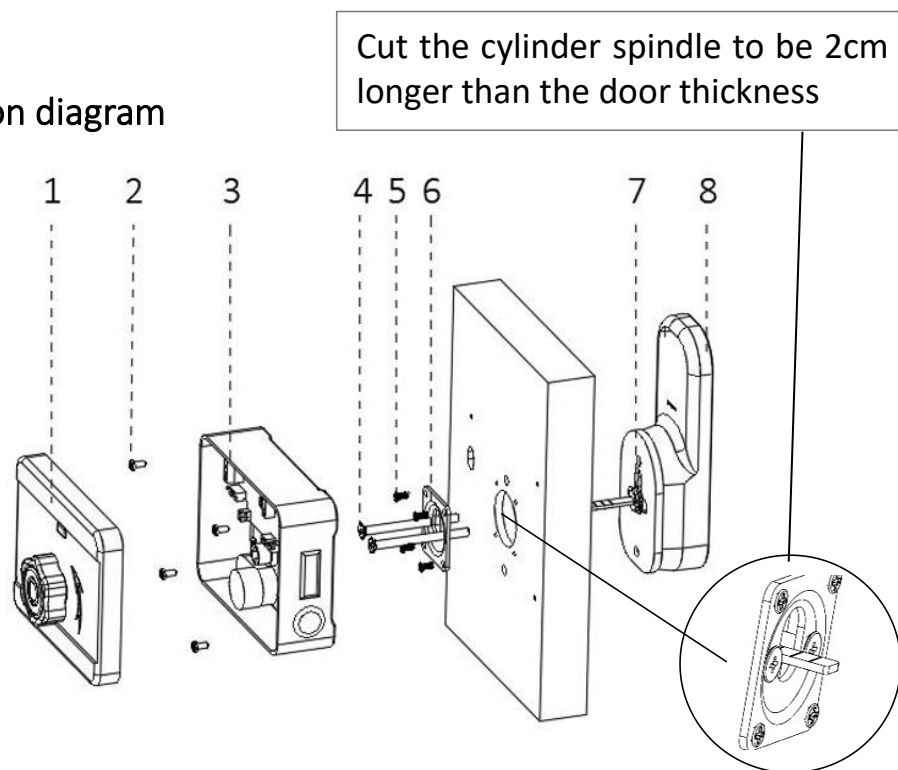

- | | | |
|---------------------|--------------------------|-----------------------|
| 1、 back panel knob | 2、 mortise fasten screws | 3、 mortise components |
| 4、 connecting screw | 5、 panel fasten screw | 6、 cylinder panel |
| 7、 Cylinder | 8、 front panel | |

Steps:

2.1) Open the front panel and insert the lock cylinder (refer to diagram 7,8).

2.2) As shown in the diagram, use the studs to connect the front panel and cylinder panel then tighten the screws to fix (refer to diagram 4,5,6).

2.3) Fix the rim mortise on the door then cover it with the back panel and fix it (refer to diagram 1,2,3).

3) Buckle installation

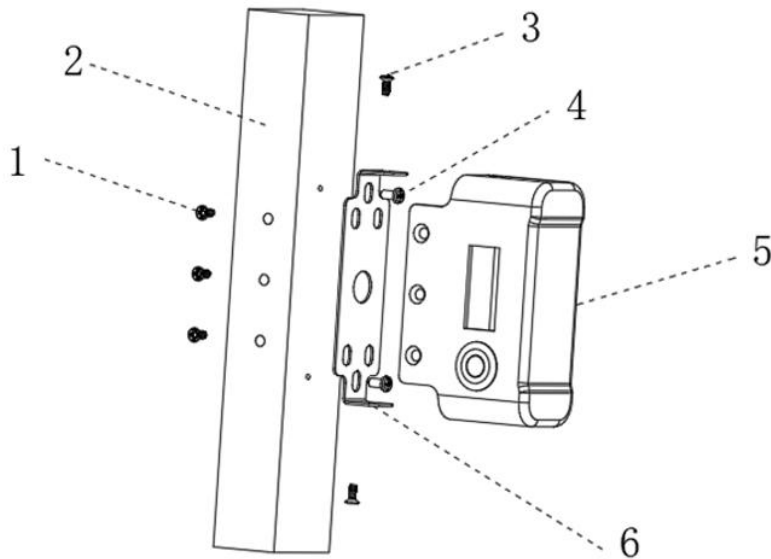

- | | |
|-----------------------------|------------------------------|
| 1、 buckle fastening screws | 2、 Door frame |
| 3、 buckle connecting screws | 4、 buckle plate fixing screw |
| 5、 buckle | 6、 buckle plate |

Steps:

- 3.1) Use the screws to fix the buckle plate on the door.
- 3.2) Use screws to fix the buckle.
- 3.3) When finish the installation, test the knob of the rim lock making sure the deadbolt fit the buckle slot well. If the unlock operation is not smooth enough, try adjusting the buckle position.

4) Function and operation

4.1) Keypad function description

4.1.1) Administrator information: refer to fingerprint, password or IC card administrator.

4.1.2) unlock information: refer to the registered fingerprint, password or IC card information (including the administrator and user).

4.1.3) "*" key: delete / back key. Enter "*" to delete the input password. Three consecutive "*" operation will clean up all the input information.

4.1.4) "#" key: operation confirm key / menu function key.

4.2) factory initial status

4.2.1) Factory initial password is 123456#. All fingerprints, IC card or 4 digits password is able to unlock under factory initial status.

4.2.2) When finish administrator registration, unregistered fingerprint, IC card or password will fail to unlock.

4.3) Lock function management menu

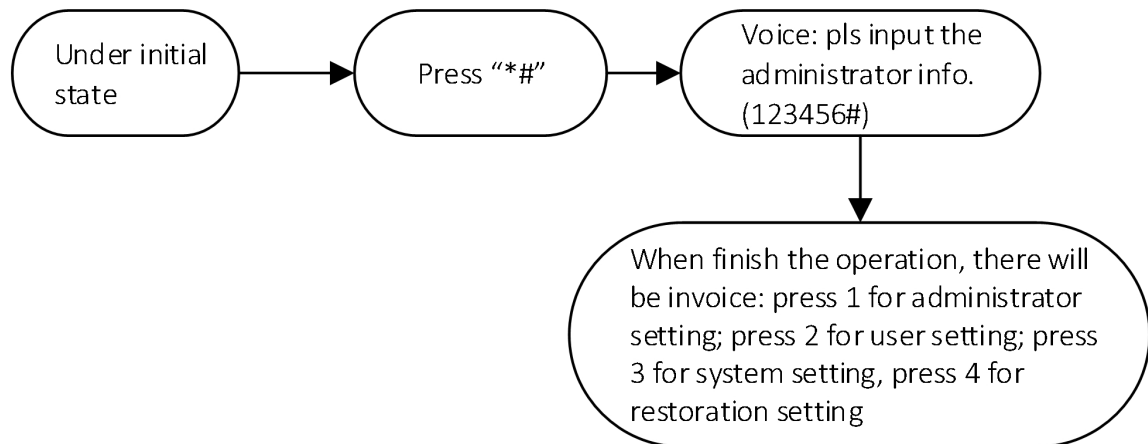

4.4) administrator setting

4.4.1) Add administrator information

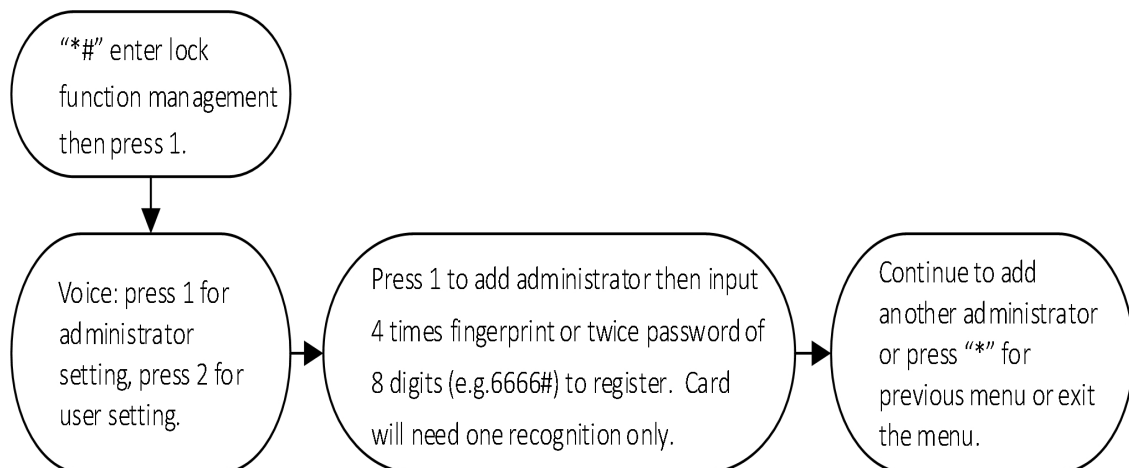

4.4.2) Delete administrator information

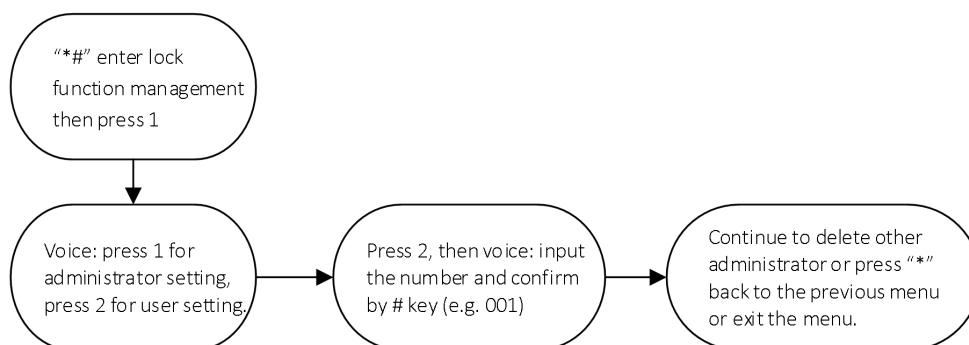

4.5) User setting

4.5.1) Add user information

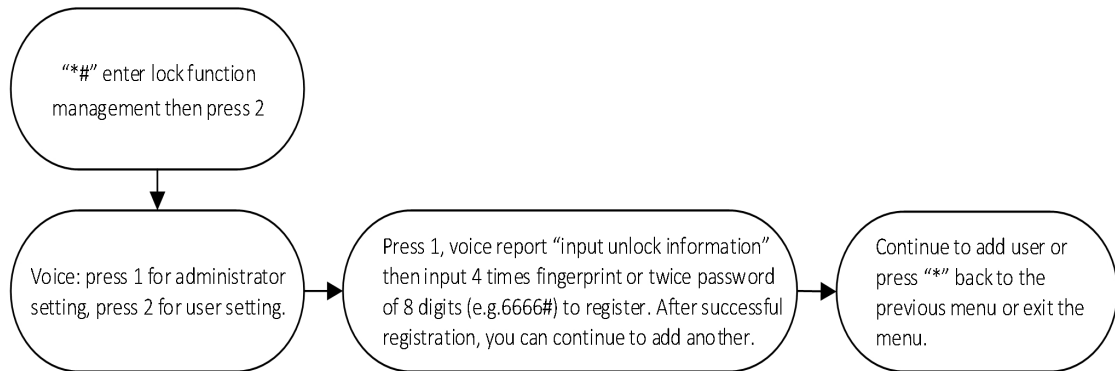

4.5.2) Delete user information

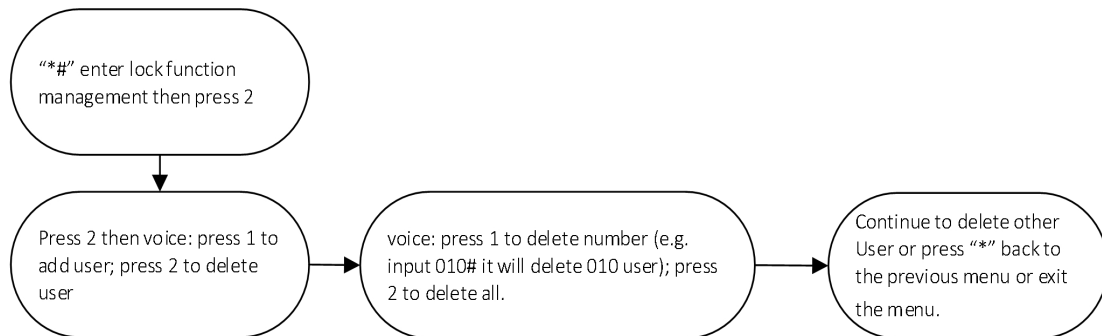

4.6) System setting

4.6.1) Voice setting

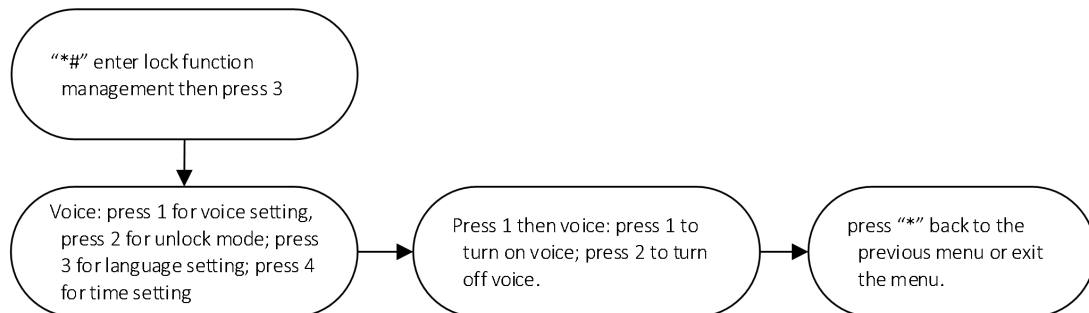

4.6.2) Unlock mode setting

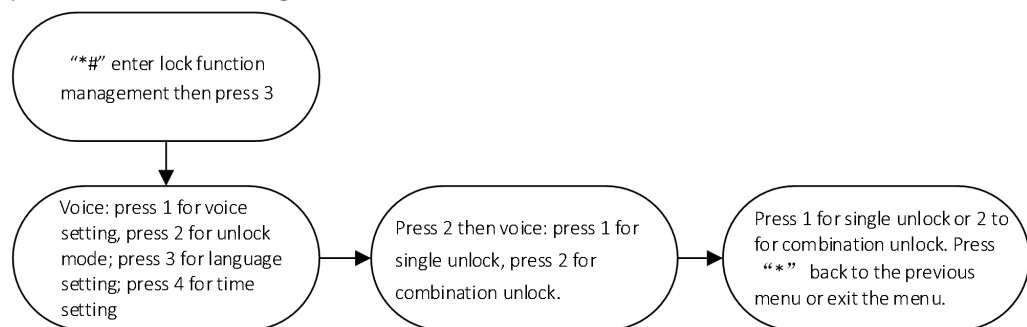

4.6.3) Language setting

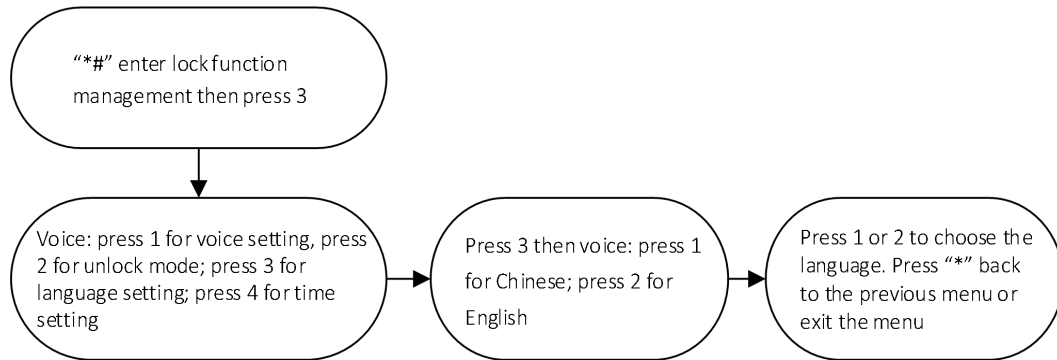

4.6.4) Time setting

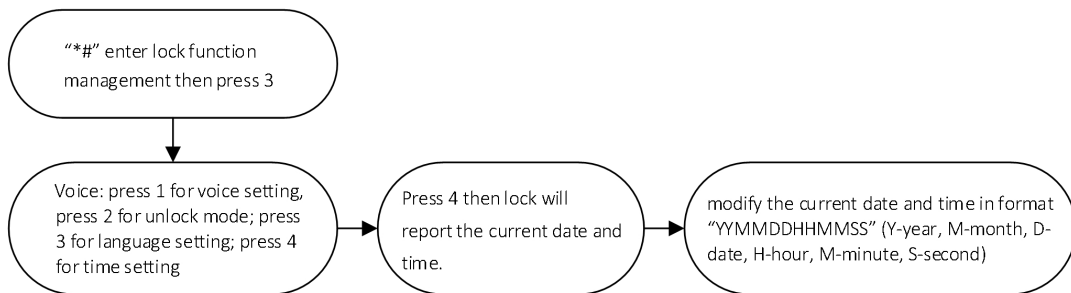

4.6.5) Reset to factory status

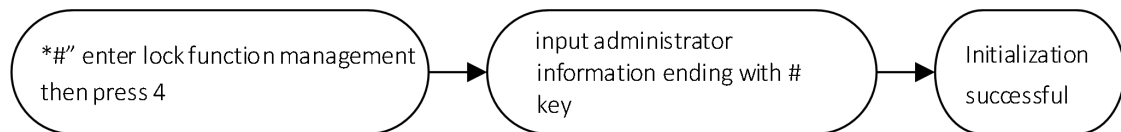

5) APP setting(Tuya Wi-Fi APP, support 2.4GHz only)



5.1) add administrator (skip this operation if you have done this)

5.2) Search "Tuya Smart" in the APP store or other APP market to download it.

5.3) Register by mobile phone number then log in.

5.4) Find in Tuya APP the "security and sensor" and press "door lock (Wi-Fi)" and follow the instruction to finish adding lock.

5.5) Net connecting

5.6) Entering Wi-Fi setting menu

1. Press **#* to verify the administrator information.
2. Press 1 to enter administrator setting menu
3. Press 3 to finish the Wi-Fi setting.

5.7) Voice reports press 1 for hotspot connection (screen indicator light flashes slowly); press 2 for intelligent connection (screen indicator light flashes rapidly). Intelligent connection is recommended.

5.7.1) Hotpot connection operation

1. Enter Wi-Fi connection menu then press 1 to choose hotspot connection.
2. Choose the Wi-Fi hotpot to be connected to then input the right password.
3. Press “Next” then it will inform you “successful”. If it failed, it will report “failed”. Please try again the operation.

5.7.2) Intelligent connection operation

1. Enter Wi-Fi connection menu then press 2 to choose intelligent connection.
2. Choose the Wi-Fi to be connected to then input the right password.
3. Press “Next” then it will inform you “successful”. If it failed, it will report “failed”. Please try again the operation.

5.8) Keypad screen number 1234 will flash successively with voice “successful” when finish adding operation; if time out, voice will report “fail”.

5.9) Remote unlock: wake the keypad and press “9#” then voice will report “requesting remote unlocking”. Door lock time will be corrected while requesting remote unlocking.

6) Remote control

6.1) Add administrator (skip this operation if you have done this)

6.2) Entering Wi-Fi setting menu

1. Press “*#” to verify the administrator information.
2. Press 2 to enter user setting menu.
3. Press 1 then press any key on the remote control when hear the voice instruction.

1) the operation of adding back panel fingerprint will be finished by front panel keypad. Operation same as that of the front panel adding fingerprint operation following the AI voice voice.

2) add IC card user following front panel keypad AI voice by swiping once on front panel or back panel.

Back panel description

- ①: visible doorbell switch
- ②: 12v power input (12V: +, GND:-)
- ③: 6v power input (4 AA alkaline batteries)
- ④: front panel connection port
- ⑤: Factory reset button
- ⑥: Motor
- ⑦: Magnet sensing port
- ⑧: Tuya (remote control) module connection port

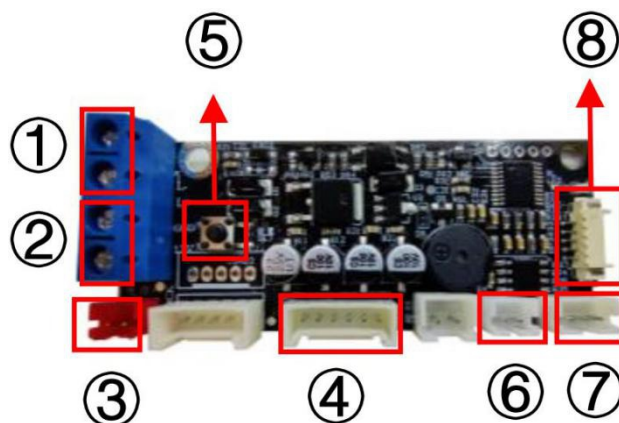

8) Other description

- 5 times wrong password input will cause a 30 seconds keypad lock. During these 30 seconds, lock will not respond to any operation.
- Anti-peeping password function: unlock by inputting before or after the correct password some random number (no more than 16 bits) then end by # key.
- The lock will give out warning alarm every unlock operation when voltage is lower than 4.8V. Please replace the battery as soon as possible.
- Reset operation: Press "SET" on the back panel for 6 seconds (screen number 654321 will automatically flash successively. The initial password will be 123456.
- Under factory initial status, you can swift the language between Chinese and English by inputting 333666999#.

9) Technical Parameter

Technical Parameter			
	Item	Parameter	Remark
1	Quiescent current	$\leq 50\mu\text{A}$	
2	Dynamic current	$\leq 180\text{mA}$	
3	Administrator capacity	9	
4	Fingerprint capacity	100	
5	FP+PWD+ card capacity	300	
6	Fingerprint scanner	Semi-conductor	
7	fingerprint recognition	$\leq 1\text{s}$	
8	FP recognition angle	360 degree	
9	False rejection rate	$\leq 0.1\%$	
10	False recognition rate	$\leq 0.0001\%$	
11	Acting time	$\leq 0.5\text{s}$	
12	Power	DC 6V	
13	Emergency power	DC 5V	
14	Working temperature	$-25^{\circ}\text{C}\sim 60^{\circ}\text{C}$	
15	Working relative humidity	20%~90%RH	
16	Human voice	YES	
17	Keypad	12 digits touching keypad	
18	Password length	4-8 digits	
19	Virtual password	32 digits	
20	Low power warning	$4.8\pm 0.2\text{V}$	
21	unlock time	$\leq 1\text{s}$	